



Gold Seal Series Amplifier

GS35, GS60, GS100, GS150, & GS250 Models

Installation and Use Manual

Notice

Every effort was made to ensure that the information in this guide was complete and accurate at the time of printing. However, information is subject to change.

Important Safety Information

WARNING: To Reduce The Risk of Fire Or Electric Shock Do Not Expose This Apparatus To Rain Or Moisture.

Always follow these basic safety precautions when installing and using the unit:

1. Read these instructions.
2. Keep these instructions.
3. Heed all warnings.
4. Follow all instructions.
5. Do not use this apparatus near water. The apparatus shall not be exposed to dripping or splashing and no objects filled with liquids, such as vases, shall be placed on the apparatus.
6. Clean only with dry cloth.
7. DO NOT block any ventilation openings. Install in accordance with the manufacturer's instructions.
8. Do not install near any heat sources such as radiators, heat registers, stoves, or other apparatus (including amplifiers) that produce heat.
9. Do not defeat the safety purpose of the polarized or grounding-type plug. A polarized plug has two blades with one wider than the other. A grounding-type plug has two blades and a third grounding prong. The wide blade, or the third prong, are provided for your safety. If the provided plug does not fit into your outlet, consult an electrician for replacement of the obsolete outlet.
10. Protect the power cord from being walked on or pinched, particularly at plugs, convenience receptacles, and the point where they exit from the apparatus.
11. Only use attachments/accessories specified by the manufacturer.
12. Unplug this apparatus during lightning storms or when unused for long periods of time.
13. Refer all servicing to qualified service personnel. Servicing is required when the apparatus has been damaged in any way, such as power-supply cord or plug is damaged, liquid has been spilled or objects have fallen into the apparatus, the apparatus has been exposed to rain or moisture, does not operate normally, or has been dropped.

Domestic and International Listings

UL and C-UL Listed.

IMPORTANT

CAUTION

**RISK OF ELECTRIC SHOCK
DO NOT OPEN**

CAUTION: TO PREVENT THE RISK OF ELECTRIC SHOCK, DO NOT REMOVE COVER (OR BACK). NO USER-SERVICEABLE PARTS INSIDE. REFER SERVICING TO QUALIFIED PERSONNEL.

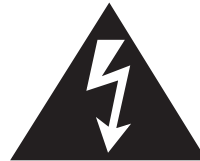

The lightning flash with arrowhead symbol, within an equilateral triangle, is intended to alert the user to the presence of uninsulated "dangerous voltage" within the product's enclosure that may be of sufficient magnitude to constitute a risk of electric shock to persons.



The exclamation point within an equilateral triangle is intended to alert the user to the presence of important operating and maintenance (servicing) instructions in the literature accompanying the appliance.

Contents

Important Safety Information	2
Introduction	5
Features	5
Packing Contents	5
Accessories	5
Panel Descriptions	6-8
Front Panel (All Models)	6
Rear Panel (Models GS35, GS60, GS100, GS150)	7
Rear Panel (GS250)	8
Input Connections	9-10
MIC 1-4	9
MIC 5/TEL	9
MIC 6/AUX 1	9
AUX 2	9
Phantom Power for MIC 5 & MIC 6	10
Remote Volume Control	10
Precedence Connections	10
Output Connections	11
Output Terminal Strip	11
WMT1A	11
To Power Amp	11
Pre-Out/Power In Jack	11
Tape Out	11
Operation	12-14
Power Switch	12
Individual Volume Controls	12
Lo-Cut Filter	12
Contour Switch	12
Audio Enhancement	12
Dual-Function Acoustic Equalizer	13
Telephone Paging Controls & Settings	14
Variable Mute	14
Troubleshooting	15
Technical Specifications	16
Limited Warranty; Exclusion of Certain Damages	17

Introduction

The Bogen Gold Seal Series amplifiers were designed with the sound contractor in mind. They provide unparalleled flexibility and versatility, without the need for add-on modules.

Unlike other typical amplifier lines, the professional sound contractor need not purchase a higher-powered amplifier just to get more extensive features or flexibility. Each of the Gold Seal Series amplifier models incorporate the exact same set of features – from 35 watts up to 250 watt models.

In addition to its extensive input flexibility, the Gold Seal Series amplifiers offer a combination of features not found in any other commercial amplifier.

Features

- 4 Dedicated microphone inputs (XLR connectors)
- 1 Selectable MIC/TEL input
- 1 Selectable MIC/AUX input
- 1 Dedicated AUX input
- 4-Ohm direct output
- 8-Ohm, 25V, 25VCT, and 70V transformer-coupled outputs
- 35W, 60W, 100W, 150W and 250W models
- Rack mountable – 2RU package for all models
- Dual-function 10-band graphic equalizer (Acoustic EQ/Feedback Control)
- True loudness contour function
- Audio Enhancement feature for improved intelligibility
- Switchable phantom power (15V DC)
- Variable AUX input muting
- Remote master volume control capability
- Input muting via contact on all inputs
- Voice-activated AUX muting on TEL input
- Automatic level control on TEL input
- AUX fade back after TEL page
- Preamp out/Power amp in connections
- Booster amp output connection
- Tape output connection
- Balanced line driver output (using WMT1A accessory)
- Lo-cut filter for MIC channels
- 3-speed fan cooling (GS250 only)
- Available tamper-resistant front cover (GSTRC)
- Available rack mounting kit (GSRPK)
- Available remote volume control (GSRVC)

Packing Contents

- 1 - Gold Seal Series Amplifier
- 1 - User Manual

Accessories

The following accessories are available for your Gold Seal Series Amplifier at additional cost:

- **Model GSTRC** — A plexiglass cover to protect control settings
- **Model GSRPK** — Rack mounting installation kit
- **Model GSRVC** — From distances up to 1000 feet away from the amplifier, this remote volume control adjusts the volume of the amplifier

Panel Descriptions

Front Panel (All Models)

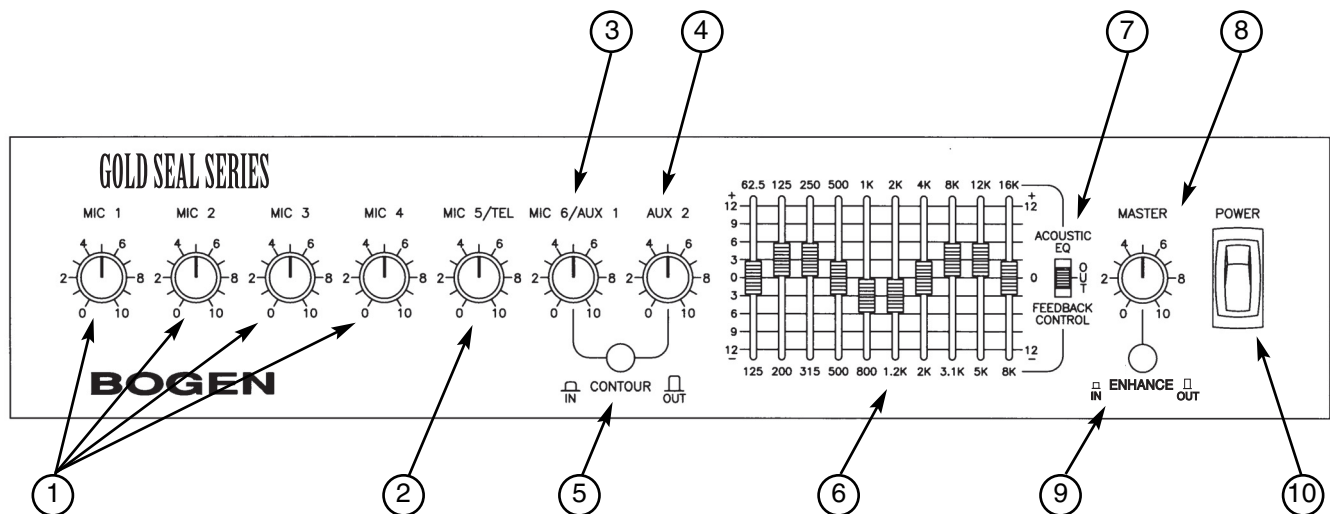

1. **MIC 1 to 4** - Individual level controls for dedicated microphone inputs.
2. **MIC 5/TEL** - Individual level control for MIC 5 or TEL input depending on input mode selected.
3. **MIC 6/AUX 1** - Individual level control for MIC 6 or AUX 1 input depending on input mode selected.
4. **AUX 2** - Individual level control for dedicated AUX 2 input.
5. **Contour** - Enables or disables loudness equalization. Affects only AUX 2 and MIC 6/AUX 1 if set in AUX mode.
6. **Dual Mode Equalizer** - 10 band graphic EQ with dual center frequency ability.
7. **Dual Mode Equalizer Selector Switch** - Selects EQ frequency bands or EQ defeat (OUT).
8. **MASTER** - Master output level control.
9. **AUDIO ENHANCEMENT** - Enables or disables the Audio Enhancement effect. Affects all input signals.
10. **POWER** - AC Power switch.

Panel Descriptions

Rear Panel (GS35, GS60, GS100 & GS150)

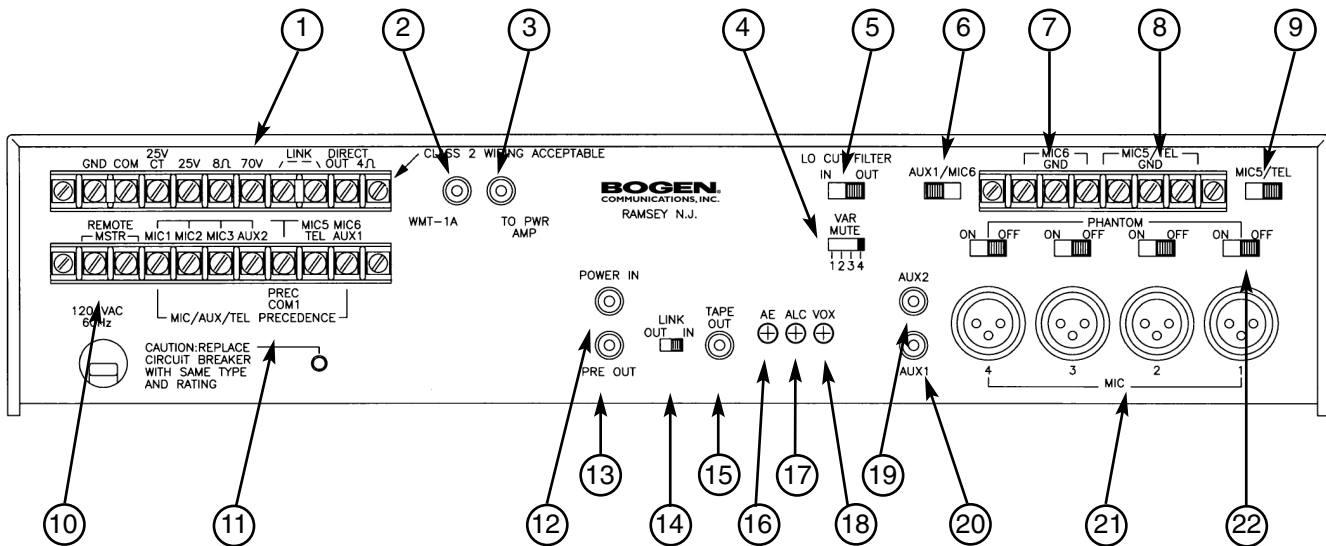

1. **Amplifier Output** - Terminal strip containing all the Gold Seal speaker outputs.
2. **WMT1A** - RCA connection for Bogen model WMT1A 600-ohm balanced line-matching transformer.
3. **TO PWR AMP** - RCA connection provides a high impedance, unbalanced signal level output as a feed to high impedance inputs of other external amplifiers.
4. **VAR MUTE** - 4 Switch selectable levels of AUX input signal muting during TEL page (works only in the TEL input mode).
5. **LO CUT FILTER** - Enables or disables low frequency roll off (65 Hz) for all microphone inputs.
6. **MIC 6/AUX 1** - Switch selects either MIC 6 or AUX 1 connections as input.
7. **MIC 6** - Screw terminals for balanced microphone (active only when AUX 1/MIC 6 switch is set to MIC 6).
8. **MIC 5/TEL** - Dual-function screw terminals for either balanced microphone or 600-ohm balanced input from telephone page port.
9. **MIC 5/TEL** - Switch selects mode of operation for MIC 5/TEL input.
10. **REMOTE MSTR** - Screw terminal pair for connection of remote master volume control (Bogen model GSRVC).
11. **MIC/AUX/TEL PRECEDENCE** - Screw terminal connections that allow externally controlled muting of individual inputs.
12. **POWER IN** - RCA unbalanced direct input to power amp stage for connection to external signal processing equipment (used in conjunction with PRE OUT and LINK switch).
13. **PRE OUT** - RCA unbalanced output from preamp/mixer stage for connection to external signal processing equipment (used in conjunction with POWER IN and LINK switch).
14. **LINK** - Switch that makes or breaks the internal connection between preamp/mixer stage and power amp stage when used with external signal processing equipment.
15. **TAPE OUT** - RCA unbalanced output, pre-EQ and master volume. (Post Lo-Cut filter, see #5).

Panel Descriptions

Rear Panel (GS250)

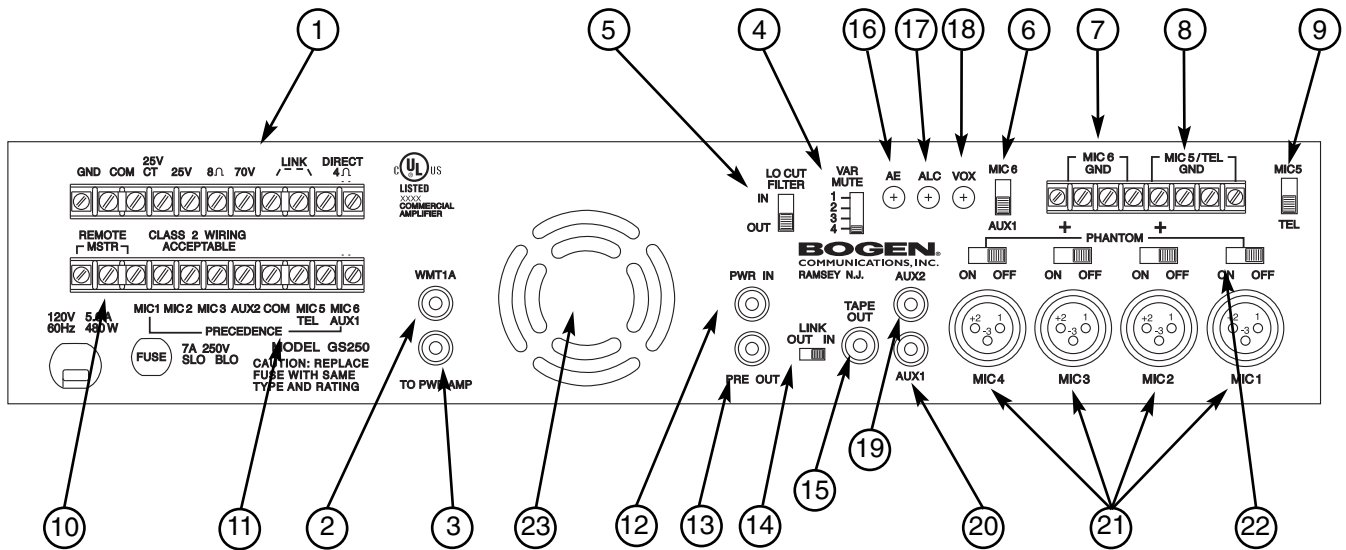

- 16. **AE** - Variable control for adjusting the amount of Audio Enhancement effect.
- 17. **ALC** - Variable control to adjust the amount of Automatic Level Control applied to the TEL input (works only in the TEL input mode).
- 18. **VOX** - Variable control for adjusting TEL input signal level trigger point for automatic muting of AUX input (works only in the TEL input mode).
- 19. **AUX 2** - RCA unbalanced input for dedicated AUX 2 input.
- 20. **AUX 1** - RCA unbalanced input for AUX 1 input signal (works only when AUX 1/MIC 6 switch is set to AUX 1).
- 21. **MIC 1 to 4** - Balanced XLR connectors for dedicated microphone inputs.
- 22. **PHANTOM (MIC 1 to 4)** - Individual switches enable or disable phantom power to each of the 4 dedicated microphone inputs (MIC 5 and MIC 6 phantom power selection — see page 10).
- 23. **Fan** - 3-speed fan for efficient cooling (GS250 only).

Input Connections

Installation Note

Keep input leads away from the output leads and AC power cables. Unless the driving source provides a low-impedance output, keep the input lead under ten feet in length. Make all connections to the unit with the POWER switch in the OFF position.

MIC 1 - 4 (Rear Panel; #21 and #22)

MIC 1 through 4 utilize female XLR-type microphone connectors. A slide switch located above each XLR connector is used to supply phantom power for condenser microphones.

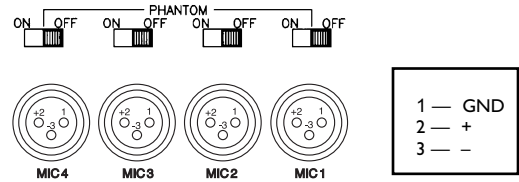

MIC 5/TEL (Rear Panel; #8 and #9)

The MIC 5/TEL input is designed to accept input from a microphone or from a telephone line. A slide switch is provided to select MIC 5 or TEL input. To connect a microphone, place the MIC 5/TEL switch in the MIC position. Use two conductor shielded cable and connect the cable shield to the center GND terminal. To use the TEL input, place the MIC 5/TEL switch in the TEL position and connect the 600-ohm telephone paging source (dry signal only - no DC voltage) to the MIC 5/TEL screw terminals. See page 10 for Phantom Power for MIC 5.

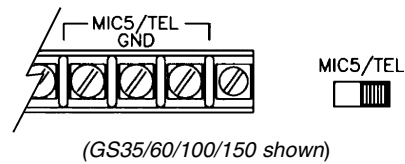

MIC 6/AUX 1 (Rear Panel; #6, #7, #20)

The MIC 6/AUX 1 input is designed to accept input from a microphone using terminal strip connections or from a high level auxiliary source such as a tuner or CD player using the AUX 1 RCA jack. A slide switch is used to select input type. Connect a microphone to the screw terminals labeled MIC 6 (works only when AUX 1/MIC 6 switch is in the MIC 6 position). Use two conductor shielded cable and connect the cable shield to the center GND terminal. Connect an auxiliary input source to the AUX 1 RCA jack (only works when the AUX 1/MIC 6 switch is in the AUX1 position.) See page 10 for Phantom Power for MIC 6.

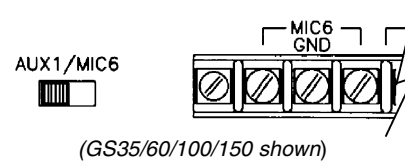

AUX1

(GS35/60/100/150 shown)

AUX 2 (Rear Panel; #19)

The AUX 2 input uses an RCA plug and accepts input from a dedicated AUX source.

AUX2



Input Connections

WARNING

Removal of the amplifier cover exposes internal components and presents an electrical shock hazard. For this reason, do not perform any functions requiring removal of the cover of the amplifier unless you are qualified to do so. Always disconnect AC power from the unit before attempting to remove the cover.

Phantom Power for MIC 5 & MIC 6 (Inside Unit)

A single internal jumper is provided to supply phantom power to both MIC 5 and MIC 6. The amplifier is shipped with the jumper in the OFF position. Place Jumper across "ON" Pins to apply Phantom Power to both MIC 5 and MIC 6. See the figure below for the location of the phantom power jumper.

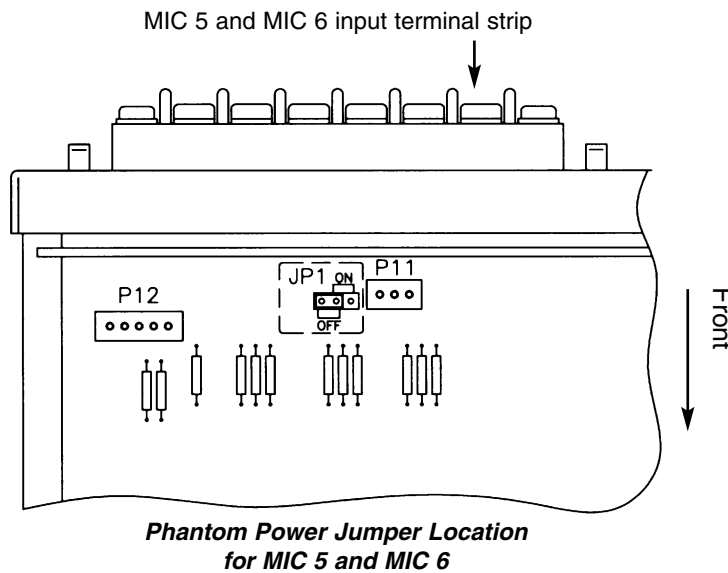

Remote Volume Control (Rear Panel; #10)

If remote volume control is desired, connect the Bogen accessory GSRVC Remote Volume Control to the screw terminals marked REMOTE MSTR. Wire length can be up to 1000 feet using 22-gauge wire. Connections are not polarity sensitive.

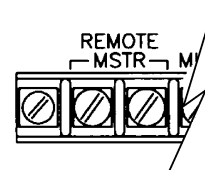

Precedence Connections (Rear Panel; #11)

Precedence connections allow any combination of inputs to be completely muted with a contact closure. Closing a contact across any of the precedence terminals and the PREC COM 1 terminal will mute that input. A customer-supplied normally-open SPST switch, push-to-talk switch, microphone switch, relay or telephone system contact can be used to provide the closure.

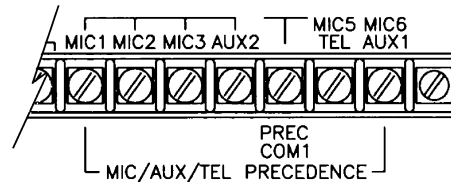

Note: Activating the precedence control for AUX inputs completely mutes the input signal. The VAR MUTE control has no effect when muting inputs using precedence control.

Output Connections

Output Terminal Strip (Rear Panel; #1)

Speaker systems are connected directly to the speaker output terminals on the rear panel. Connect one speaker lead to the COM terminal and the other to the terminal corresponding to the impedance of the speaker system. Select only one of the output types.

For ground-referenced output operation (unbalanced systems), leave the shorting clip between COM and GND. For special applications that require floating outputs (balanced systems), remove the shorting clip between COM and GND.

Note: If GND/COM shorting clip is removed, the WMT1A and "TO PWR AMP" outputs will not operate.

To use the DIRECT OUT (4-ohm) output, remove the shorting clip across the LINK terminals and connect low impedance speaker load between the 4Ω terminal and the GND terminal. The GND/COM shorting clip should remain in place.

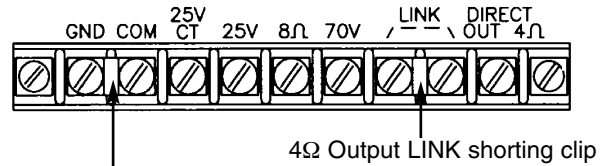

Shorting Clip - Leave for unbalanced output lines. Remove for balanced output lines.

WMT1A (Rear Panel; #2)

This RCA output jack, when used with a Bogen WMT1A Line-Matching Transformer accessory provides a 600-ohm output to feed a remote amplifier or a telephone line. Refer to the instructions provided with the WMT1A accessory for connection information.

Note: Shorting clip between GND/COM on the speaker output terminals strip must be installed to use this feature.



WMT-1A

To Power Amp (Rear Panel; #3)

The Gold Seal Series amplifier may be used to drive an external power amplifier (can only be used with unbalanced high-impedance inputs).

Note: Shorting clip between GND/COM on the speaker output terminal strip must be installed to use this feature.



TO PWR AMP

Pre-Out/Power In Jacks (Rear Panel; #12, #13, #14)

These jacks permit the insertion of signal processing equipment into the signal path between the preamp output and the power amp input.

The LINK switch should be in the IN position for normal operation. When using external signal processing equipment, place the switch in the OUT position and connect PRE OUT to the signal processing equipment's input. Connect the POWER IN to the signal processing equipment's output.

Note: Ensure that the LINK switch is in the IN position when NOT using external signal processing equipment, otherwise there will be no output from the amplifier.

POWER IN



PRE OUT



Tape Out (Rear Panel; #15)

The TAPE OUT jack provides a line-level output to feed a recording device. The output is not effected by the Master volume control or EQ, however, the output is affected by the microphone inputs' Lo-Cut filter.

TAPE OUT



Operation

Power Switch (Front Panel; #10)

The POWER switch applies power to the unit. The switch will illuminate when power is on.



Individual Volume Controls (Front Panel; #1)

Controls (Front Panel; #1)

Each input is controlled by an individual volume control.

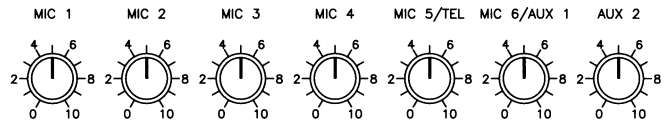

Master Volume Control (Front Panel; #8)

The overall volume is controlled by the MASTER volume control.



Lo-Cut Filter (Rear Panel; #5)

The Lo-Cut filter on the rear panel provides 3 dB attenuation @ 65Hz on the microphone inputs. This helps reduce mic breath pop, wind noise, and rumble.



Contour Switch (Front Panel; #5)

This switch enables or bypasses the variable loudness contour. This feature only effects the AUX inputs.

This feature is designed to improve richness of sound by restoring the high and low frequencies that the ear is insensitive to at low volume levels. The effect diminishes as volume is increased.

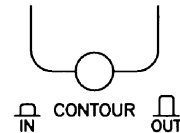

Audio Enhancement (Front Panel; #9 / Rear Panel; #16)

(Front Panel; #9 / Rear Panel; #16)

The front panel Audio Enhancement switch enables or bypasses the Audio Enhancement feature. This feature effects all inputs when enabled.

By regenerating the upper harmonics, this audio enhancement system recreates the presence and realism that is lost in the audio amplification process. This results in increased presence and clarity, increased intelligibility, greater perceived loudness (without using extra power), and reduced listener fatigue.

The rear panel AE adjustment controls the mix of the Audio Enhancement effect with the audio signal. Counterclockwise rotation of the control minimizes the Audio Enhancement effect. Clockwise rotation of the control maximizes the Audio Enhancement effect.



Dual-Function Acoustic Equalizer (Front Panel; #6)

The unique dual-function equalizer can be used for acoustic shaping or for feedback control.

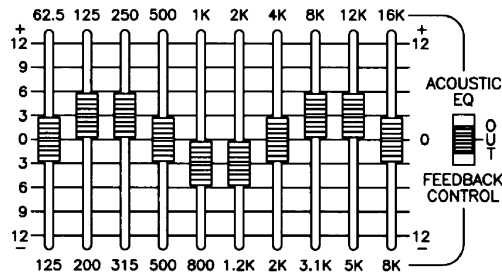

Note: When the switch is placed in the OUT position, the equalizer is bypassed for a flat response.

Acoustic Shaping Mode

When the switch is set in the ACOUSTIC EQ position, full range equalization (10 bands on 1 octave centers starting at 62.5 Hz) is provided with a boost/cut of 12 dB. In this mode, the equalizer can be used to compensate for room acoustics, or to satisfy the listening preference of the user.

Feedback Control Mode

When the switch is placed in the FEEDBACK CONTROL position, the equalizer can be used to reduce feedback and increase the effective gain of the system.

In feedback control mode, the equalizer provides increased control of frequencies between 125 Hz and 8 kHz. The 10 bands are located on 2/3 octave centers with 12 dB cut/boost on each band.

Operation

Telephone Paging Controls & Settings

The MIC 5/TEL volume control on the front panel controls the volume of the telephone paging input when the control is set to the TEL mode (See page 9 for information on setting the TEL input mode).

The TEL input mode uses voice-activated muting for the AUX inputs and automatic level control for providing constant paging level. To optimize TEL input performance, both the ALC control and the VOX threshold may need to be adjusted.

ALC (Rear Panel; #17)

The TEL input features an automatic level control (ALC) which compensates for different voice levels and speaking styles of the individuals using the system. The amplifier is shipped with this control in the OFF (max. counterclockwise) position.



To adjust the ALC:

1. Rotate the MIC 5/TEL and MASTER controls to the highest level likely to be used.
2. Speak softly and distinctly into the telephone mouthpiece while adjusting the MIC 5/TEL volume control to the desired output level.
3. Speak in a loud voice directly into the telephone mouthpiece while rotating the ALC control clockwise to the point where the output of the amplifier is reduced to the same level as that obtained in Step 2.
4. The MIC 5/TEL and MASTER controls can be used to vary the overall volume without upsetting the ALC adjustment.

VOX (Rear Panel; #18)

The telephone page input features voice-activated AUX muting. This feature always mutes AUX 2 and only mutes AUX 1 when the AUX1/MIC 6 switch is set in that position.

The VOX control should be set so that only the desired signal is above the threshold level, while unwanted noise is below it.



To adjust the sensitivity of the VOX circuit:

1. Rotate the VOX control fully clockwise. While making a public address announcement and talking at a low level, the sound should not be choppy or missing parts of words. If it is choppy or intelligibility is poor, rotate control counterclockwise to the point where the sound is clear and crisp (but not to the maximum counterclockwise position).
2. If the background music shuts down when no page is in progress, rotate the control clockwise until the music will not shut down when no page is in progress.

Variable Mute (Rear Panel; #4)

The VAR MUTE control mutes the AUX input(s) only during telephone pages.

The control allows the user to select from 4 levels of muting: 1 = -60 dB, 2 = -21 dB, 3 = -10 dB, 4 = 0 dB.



Troubleshooting

<p>Amplifier will not turn ON.</p>	<p>On the GS35, GS60, GS100 and GS150, depress the circuit breaker reset button.</p> <p>On the GS250, check the fuse. Replace fuse only with same type and rating.</p>
<p>No output on 70V, 25 VCT, or 25V.</p>	<p>Check that the LINK switch on the rear panel is in the IN position or external signal-processing equipment, if used, is functioning and connected properly.</p> <p>Make sure that the speaker output LINK shorting clip is in place.</p>
<p>No telephone output.</p>	<p>Make sure that the MIC 5/TEL switch is in the TEL position.</p> <p>Make sure the VOX control is set properly</p> <p>When connecting the telephone Tip & Ring, make sure to use the two outside terminals and not the center terminal (GND).</p>
<p>AUX input will not mute with telephone page.</p>	<p>Check that the VAR MUTE control is not set to 4 (0 dB). This control adjusts the level of the background music when making a page. See page 14.</p>
<p>Microphone squeals or hums when using the 3-pin connectors but not when using screw terminals.</p>	<p>Check your wiring connections for the 3-pin connector. Pin 1 is the shield connection. Pins 2 and 3 connect to the balanced signal leads on the mic cable.</p>
<p>Condenser MIC will not work.</p>	<p>Make sure that phantom power switch (MIC 1 - 4) is on. See page 9.</p> <p>MIC 5 and 6 use circuit board jumper. See page 10.</p>
<p>Telephone input cuts off the music, when not making a page.</p>	<p>Adjust the VOX control on the rear panel to eliminate any unwanted noise that may be triggering the VAR MUTE circuit. See page 14.</p>
<p>Telephone input is choppy or cuts off the beginning of a page.</p>	<p>Adjust the VOX control counterclockwise to make the trigger activate at a lower input signal level. See page 14.</p>
<p>The telephone page volume is too loud on some pages.</p>	<p>Adjust the ALC control on the rear panel. See page 14.</p>
<p>AUX 1 input not working</p>	<p>Make sure MIC 6/AUX 1 switch is in the AUX 1 position.</p> <p>Make sure the signal source is plugged into the AUX 1 RCA jack.</p>

Technical Specifications

Power Rating (RMS):	GS35: 35 watts; GS60: 60 watts; GS100: 100 watts; GS150: 150 watts; GS250: 250 watts
Frequency Response:	<i>Transformer Output:</i> 65 Hz to 20 kHz, +0/-2 dB @ -2 dB <i>Direct Output:</i> 20 Hz to 20 kHz, +0/-1 dB @ rated power
Distortion:	<i>Transformer Output:</i> 0.5% (max.), 0.3% (typ.), 65 Hz to 20 kHz @ -2 dB <i>Direct Output:</i> 0.5% (max.), 0.3% (typ.), 20 Hz to 20 kHz
Signal-to-Noise Ratio:	<i>Fundamental:</i> -94 dB or better; AUX 1 & 2: -70 dB; Tel: -70 dB or better @ 600 ohms <i>MIC 1 through MIC 6:</i> -60 dB or better @ 200 ohms
Inputs/Outputs:	<i>MIC:</i> 6 Lo-Z balanced via 4 XLR connectors and 2 screw terminals <i>Sensitivity:</i> 0.35 mV (200 ohms) <i>AUX:</i> 2 Hi-Z RCA jacks. Sensitivity: 0.085V (10k ohms) <i>Telephone:</i> Screw terminals. Sensitivity: 0.07V (600 ohms) <i>Output to Power Amp:</i> 5V @ Rated Output via RCA jack <i>Power In/Pre Out:</i> In 1V/Out 1V via RCA jacks <i>WMT1A Output:</i> 25V @ Rated Output via RCA jack <i>Tape Output:</i> 687 mV @ Rated Output via RCA jack
Output Impedance:	All models: balanced or unbalanced 8-ohms, 25V, 25VCT, 70V, 4-ohm direct
Output Regulation:	Better than 2 dB from no load to full load
AC Input Voltage:	120V~ 60 Hz
AC Current:	GS35: 0.9A; GS60: 1.3A; GS100: 2.2A; GS150: 3.0A; GS250: 5.0A
Thermal Emissions (Full Power):	GS35: 122.9 BTU/hr.; GS60: 283.5 BTU/hr.; GS100: 365.4 BTU/hr.; GS150: 642.1 BTU/hr.; GS250: 847 BTU/hr.
Variable Mute Range:	-60, -21, -10, 0 dB (AUX1 & 2)
ALC:	Distortion: less than 0.5%; Compression: 25 dB (TEL)
VOX Threshold:	TEL Input 20 mV (VOX control max. CW position)
MIC Precedence:	Via terminal strip. -60 dB: MIC 1, 2, 3, 5/TEL, 6/AUX, AUX 2
Power In/Pre Out:	In 1V/Out 1V via RCA jacks
Loudness Contour:	+8 dB @ 100 Hz, +4 dB @ 10 kHz (AUX 1 & 2 control at 1/4 CW position)
Overload Protection:	Electronic with automatic reset
Thermal Protection:	Thermistor attached to heat sink
Operating Temperature Range:	-10°C (14°F) to 60°C (140°F)
Line Fusing:	Resettable circuit breaker (GS250 uses a Fuse)
Dimensions:	GS35/60/100/150: 16-1/2" W x 3-1/2" H x 12" D; GS250: 16-1/2" W x 3-1/2" H x 13-1/2" D
Shipping Weight:	GS35: 19 lb.; GS60: 24 lb.; GS100: 28 lb.; GS150: 31 lb.; GS250: 30 lb.

Limited Warranty; Exclusion of Certain Damages

Bogen's **Gold Seal Series** amplifiers are warranted to be free from defects in material or workmanship for three (3) years from the date of sale to the original purchaser. Any part of any Bogen product covered by this warranty that, with normal installation and use, becomes defective (as confirmed by Bogen upon inspection) during the applicable warranty period, will be repaired or replaced by Bogen, at Bogen's option, provided the product is shipped insured and prepaid to: Bogen Factory Service Department, 50 Spring Street, Ramsey, NJ 07446, USA. Repaired or replacement product will be returned to you freight prepaid. This warranty does not extend to any of our products that have been subjected to abuse, misuse, improper storage, neglect, accident, improper installation or have been modified or repaired or altered in any manner whatsoever, or where the serial number or date code has been removed or defaced.

THE FOREGOING LIMITED WARRANTY IS BOGEN'S SOLE AND EXCLUSIVE WARRANTY AND THE PURCHASER'S SOLE AND EXCLUSIVE REMEDY. BOGEN MAKES NO OTHER WARRANTIES OF ANY KIND, EITHER EXPRESS OR IMPLIED, AND ALL IMPLIED WARRANTIES OF MERCHANTABILITY OR FITNESS FOR A PARTICULAR PURPOSE ARE HEREBY DISCLAIMED AND EXCLUDED TO THE MAXIMUM EXTENT ALLOWABLE BY LAW. Bogen's liability arising out of the manufacture, sale or supplying of products or their use or disposition, whether based upon warranty, contract, tort or otherwise, shall be limited to the price of the product. **IN NO EVENT SHALL BOGEN BE LIABLE FOR SPECIAL, INCIDENTAL OR CONSEQUENTIAL DAMAGES (INCLUDING, BUT NOT LIMITED TO, LOSS OF PROFITS, LOSS OF DATA OR LOSS OF USE DAMAGES) ARISING OUT OF THE MANUFACTURE, SALE OR SUPPLYING OF PRODUCTS, EVEN IF BOGEN HAS BEEN ADVISED OF THE POSSIBILITY OF SUCH DAMAGES OR LOSSES.** Some States do not allow the exclusion or limitation of incidental or consequential damages, so the above limitation or exclusion may not apply to you. This warranty gives you specific legal rights, and you may also have other rights which vary from State to State.

Products that are out of warranty will also be repaired by the Bogen Factory Service Department -- same address as above or call 201-934-8500. The parts and labor involved in these repairs are warranted for 90 days when repaired by the Bogen Factory Service Department. All shipping charges in addition to parts and labor charges will be at the owner's expense. All returns require a Return Authorization number. For most efficient warranty or repair service, please include a description of the failure.

Products manufactured and labeled by other companies may be covered by warranties offered by such companies. Please call Bogen Customer Service or refer to product packaging for manufacturer's warranty for non-Bogen branded products.

12/2008

Notes

BOGEN[®]
COMMUNICATIONS, INC.
50 Spring Street, Ramsey, NJ 07446
Tel. 201-934-8500 • Fax: 201-934-9832
www.bogen.com